

| | |
|-----------|-------|
| PROJECT | _____ |
| TYPE | _____ |
| SPECIFIER | _____ |
| QUANTITY | _____ |
| DATE | _____ |

INFINITE ROUND SUSPENSION

A51058- -

base number
 Color Temperature Finish Options

- To build a product code in our configurator select the specify button on the base model # product page
- To build a manual product code on this datasheet choose from the options listed below in blue font and add the suffix to the base model #

GENERAL

Series: Infinite Round
 Partner: Ivela
 Division: Architectural
 Installation: Suspension
 Product Type: Panels
 Mounting Location: Ceiling
 Light Distribution: Direct

PHYSICAL

Shape: Round
 Diameter (mm): 612
 Diameter (in): 24 1/8
 Height (mm): 19
 Height (in): 3/4
 Max. Overall Height (mm): 2500
 Max. Overall Height (in): 98 7/16
 Diffuser: Opal Polycarbonate
 Fixture Finish: WHI / BLK / GLD
 Fixture Material: Aluminum

ELECTRICAL

Lamp Type: LED
 Input Wattage (W): 38
 Dimming: Tri-Mode (Non-Dimming and Phase Dimming (120Vac only) and 0-10V Dimming)
 Driver Included: No
 Driver Location: Remote
 Driver Type: Constant Voltage - Universal
 Driver Class: Class 2
 Housing: ENCP 5 (ERP) ENCP 13 (SC Power)
 Input Voltage (V): 120 - 277
 Output Voltage (V): 24

LED

Color Temperature (°K): 2700 / 3000 / 3500 / 4000
 Max. Delivered Lumen (lm): 2160 / 2250 / 2317 / 2385
 Nominal Lumen (lm): 4320 / 4500 / 4634 / 4770
 CRI: >93 CRI
 Lamp Life (hrs): 50000

OPTICAL

RATINGS AND CERTIFICATIONS

Certified By: Certified for North American Standards
 IP rating: IP20

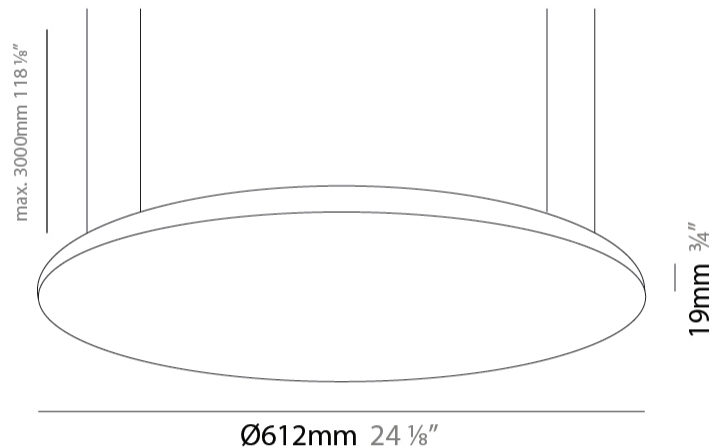

INFINITE ROUND SUSPENSION

A51058-

PROJECT _____

TYPE _____

SPECIFIER _____

QUANTITY _____

DATE _____

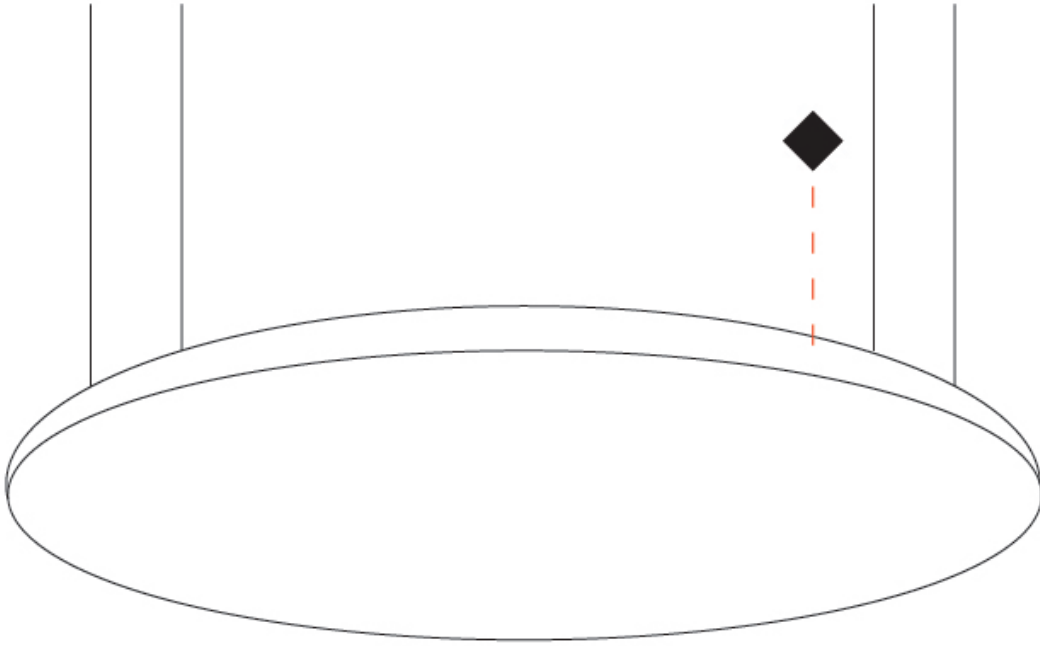

| | |
|-----------|-------|
| PROJECT | _____ |
| TYPE | _____ |
| SPECIFIER | _____ |
| QUANTITY | _____ |
| DATE | _____ |

INFINITE ROUND SUSPENSION

A51059- -

base number
 Color Temperature Finish Options

- To build a product code in our configurator select the specify button on the base model # product page
- To build a manual product code on this datasheet choose from the options listed below in blue font and add the suffix to the base model #

GENERAL

Series: Infinite Round
 Partner: Ivela
 Division: Architectural
 Installation: Suspension
 Product Type: Panels
 Mounting Location: Ceiling
 Light Distribution: Direct

PHYSICAL

Shape: Round
 Diameter (mm): 899
 Diameter (in): 35 ³/₈
 Height (mm): 19
 Height (in): 3/4
 Max. Overall Height (mm): 2500
 Max. Overall Height (in): 98 ⁷/₁₆
 Diffuser: Opal Polycarbonate
 Fixture Finish: WHI / BLK / GLD
 Fixture Material: Aluminum

ELECTRICAL

Lamp Type: LED
 Input Wattage (W): 56
 Dimming: Tri-Mode (Non-Dimming and Phase Dimming (120Vac only) and 0-10V Dimming)
 Driver Included: No
 Driver Location: Remote
 Driver Type: Constant Voltage - Universal
 Driver Class: Class 2
 Housing: ENCP 5 (ERP) ENCP 8 (SC Power)
 Input Voltage (V): 120 - 277
 Output Voltage (V): 24

LED

Color Temperature (°K): 2700 / 3000 / 3500 / 4000
 Max. Delivered Lumen (lm): 3360 / 3500 / 3604 / 3710
 Nominal Lumen (lm): 6720 / 7000 / 7208 / 7420
 CRI: >93 CRI
 Lamp Life (hrs): 50000

OPTICAL

RATINGS AND CERTIFICATIONS

Certified By: Certified for North American Standards
 IP rating: IP20

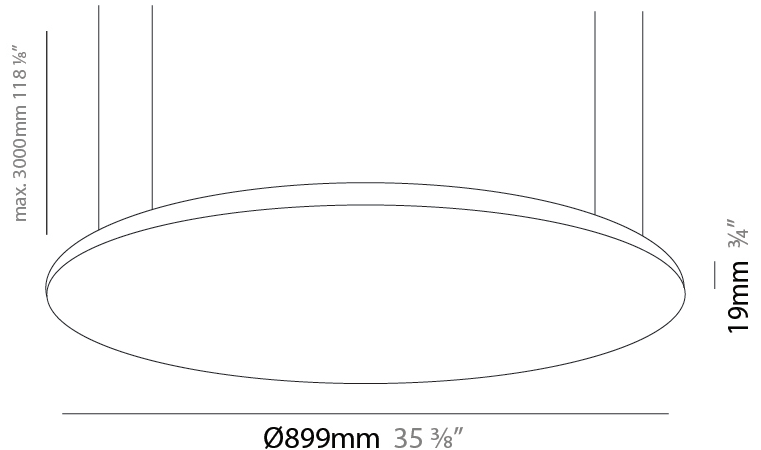

INFINITE ROUND SUSPENSION

A51059-

PROJECT

TYPE

SPECIFIER

QUANTITY

DATE

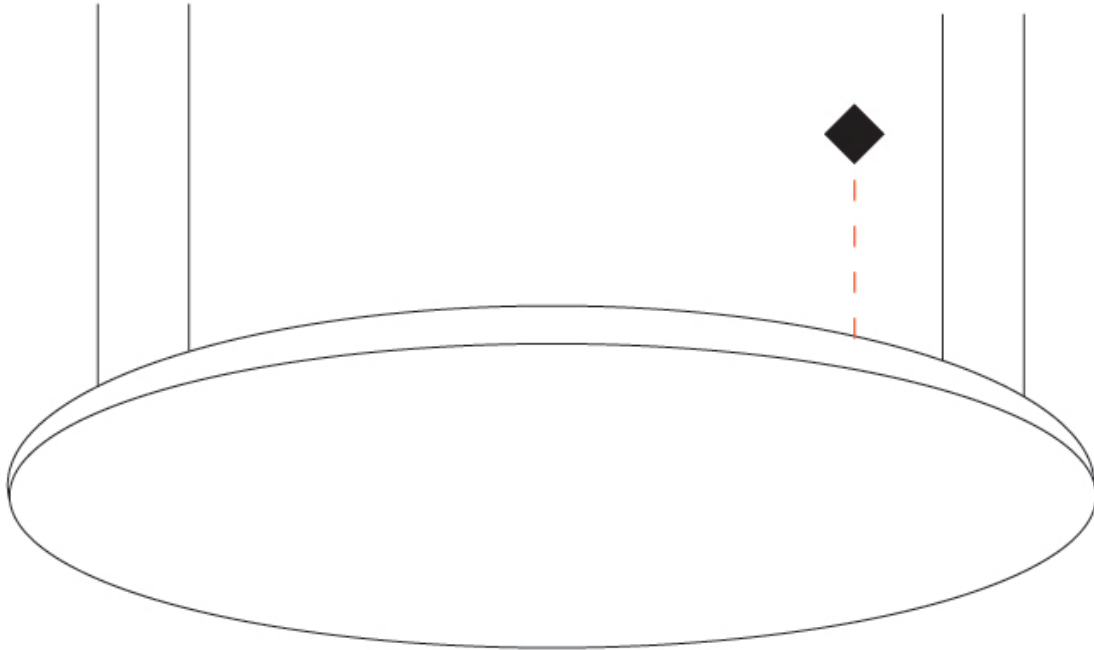

PROJECT _____
 TYPE _____
 SPECIFIER _____
 QUANTITY _____
 DATE _____

INFINITE ROUND SUSPENSION

A51060- _____
 base number Color _____ Finish _____
 Temperature Options

- To build a product code in our configurator select the specify button on the base model # product page
- To build a manual product code on this datasheet choose from the options listed below in blue font and add the suffix to the base model #

GENERAL

Series: Infinite Round
 Partner: Ivela
 Division: Architectural
 Installation: Suspension
 Product Type: Panels
 Mounting Location: Ceiling
 Light Distribution: Direct

PHYSICAL

Shape: Round
 Diameter (mm): 1216
 Diameter (in): 47 ⁷/₈
 Height (mm): 19
 Height (in): 3/4
 Max. Overall Height (mm): 2500
 Max. Overall Height (in): 98 ⁷/₁₆
 Diffuser: Opal Polycarbonate
 Fixture Finish: WHI / BLK / GLD
 Fixture Material: Aluminum

ELECTRICAL

Lamp Type: LED
 Input Wattage (W): 78
 Dimming: Tri-Mode (Non-Dimming and Phase Dimming (120Vac only) and 0-10V Dimming)
 Driver Included: No
 Driver Location: Remote
 Driver Type: Constant Voltage - Universal
 Driver Class: Class 2
 Housing: ENCP 5 (ERP) ENCP 8 (SC Power)
 Input Voltage (V): 120 - 277
 Output Voltage (V): 24

LED

Color Temperature (°K): 2700 / 3000 / 3500 / 4000
 Max. Delivered Lumen (lm): 4560 / 4750 / 4891 / 5035
 Nominal Lumen (lm): 9120 / 9500 / 9783 / 10070
 CRI: >93 CRI
 Lamp Life (hrs): 50000

OPTICAL

RATINGS AND CERTIFICATIONS

Certified By: Certified for North American Standards
 IP rating: IP20

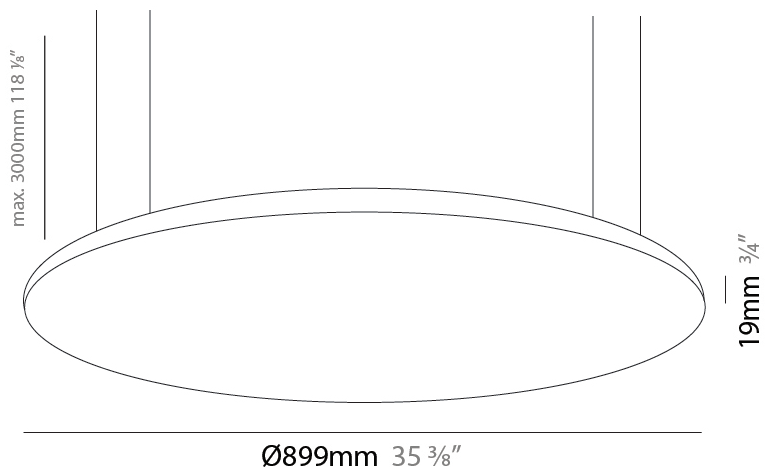

INFINITE ROUND SUSPENSION

A51060-

| | |
|-----------|-------|
| PROJECT | _____ |
| TYPE | _____ |
| SPECIFIER | _____ |
| QUANTITY | _____ |
| DATE | _____ |

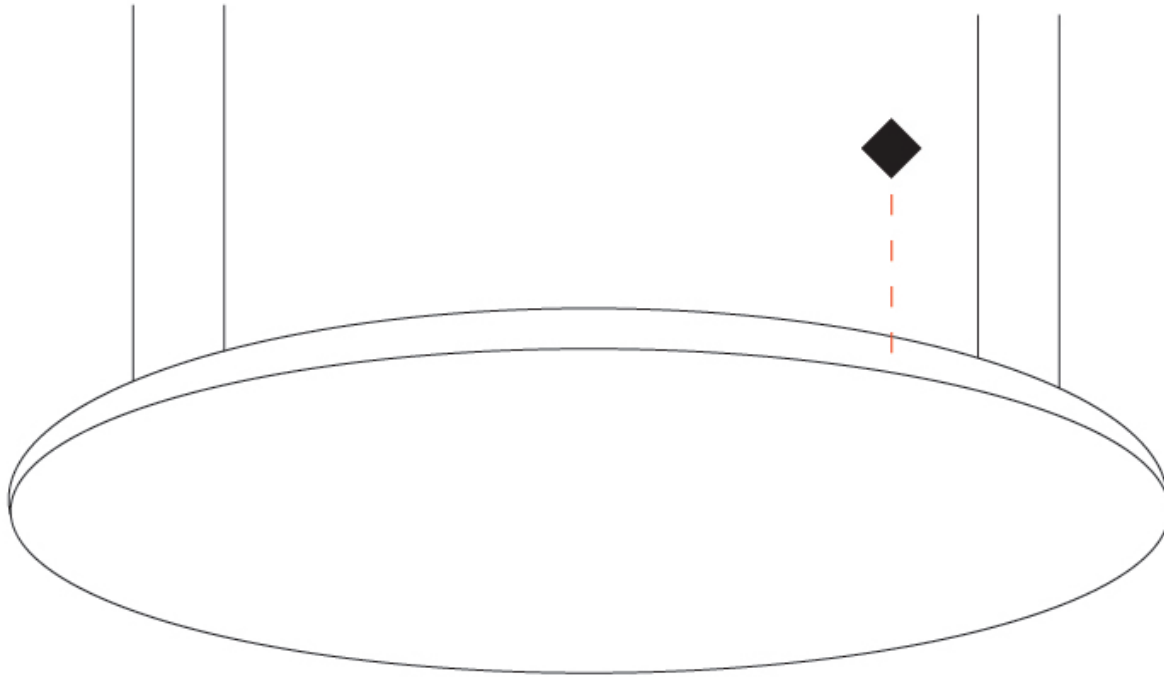

| |
|-----------|
| PROJECT |
| TYPE |
| SPECIFIER |
| QUANTITY |
| DATE |

INFINITE ROUND SURFACE

A52029- -
 base number Color Finish
 Temperature Options

- To build a product code in our configurator select the specify button on the base model # product page
- To build a manual product code on this datasheet choose from the options listed below in blue font and add the suffix to the base model #

GENERAL

Series: Infinite Round
 Partner: Ivela
 Division: Architectural
 Installation: Surface
 Product Type: Panels
 Mounting Location: Ceiling
 Light Distribution: Direct

PHYSICAL

Shape: Round
 Diameter (mm): 612
 Diameter (in): 24 1/8
 Height (mm): 19
 Height (in): 3/4
 Diffuser: PMMA - Opal
 Fixture Finish: WHI / BLK / GLD
 Fixture Material: Aluminum

ELECTRICAL

Lamp Type: LED
 Input Wattage (W): 38
 Dimming: Tri-Mode (Non-Dimming and Phase Dimming (120Vac only) and 0-10V Dimming)
 Driver Included: No
 Driver Location: Remote
 Driver Type: Constant Voltage - Universal
 Driver Class: Class 2
 Housing: ENCP 5 (ERP) ENCP 13 (SC Power)
 Input Voltage (V): 120 - 277
 Output Voltage (V): 24

LED

Color Temperature (°K): 2700 / 3000 / 3500 / 4000
 Max. Delivered Lumen (lm): 2160 / 2250 / 2317 / 2385
 Nominal Lumen (lm): 4320 / 4500 / 4634 / 4770
 CRI: >93 CRI
 Lamp Life (hrs): 50000

OPTICAL

RATINGS AND CERTIFICATIONS

Certified By: CSA Certified to UL and CSA Standards
 IP rating: IP20

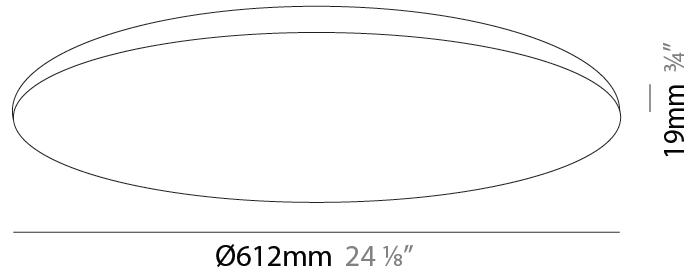

INFINITE ROUND SURFACE

A52029-

PROJECT

TYPE

SPECIFIER

QUANTITY

DATE

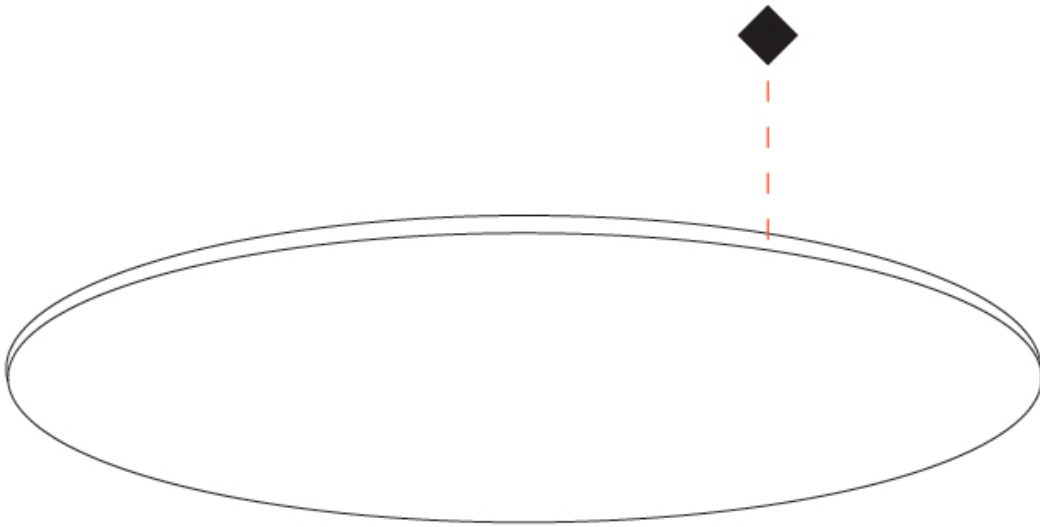

| |
|-----------|
| PROJECT |
| TYPE |
| SPECIFIER |
| QUANTITY |
| DATE |

INFINITE ROUND SURFACE

A52030- -
 base number Color Finish
 Temperature Options

- To build a product code in our configurator select the specify button on the base model # product page
- To build a manual product code on this datasheet choose from the options listed below in blue font and add the suffix to the base model #

GENERAL

Series: Infinite Round
 Partner: Ivela
 Division: Architectural
 Installation: Surface
 Product Type: Panels
 Mounting Location: Ceiling
 Light Distribution: Direct

PHYSICAL

Shape: Round
 Diameter (mm): 899
 Diameter (in): 35 ³/₈
 Height (mm): 19
 Height (in): 3/4
 Diffuser: PMMA - Opal
 Fixture Finish: WHI / BLK / GLD
 Fixture Material: Aluminum

ELECTRICAL

Lamp Type: LED
 Input Wattage (W): 56
 Dimming: Tri-Mode (Non-Dimming and Phase Dimming (120Vac only) and 0-10V Dimming)
 Driver Included: No
 Driver Location: Remote
 Driver Type: Constant Voltage - Universal
 Driver Class: Class 2
 Housing: ENCP 5 (ERP) ENCP 8 (SC Power)
 Input Voltage (V): 120 - 277
 Output Voltage (V): 24

LED

Color Temperature (°K): 2700 / 3000 / 3500 / 4000
 Max. Delivered Lumen (lm): 3360 / 3500 / 3604 / 3710
 Nominal Lumen (lm): 6720 / 7000 / 7208 / 7420
 CRI: >93 CRI
 Lamp Life (hrs): 50000

OPTICAL

RATINGS AND CERTIFICATIONS

Certified By: CSA Certified to UL and CSA Standards
 IP rating: IP20

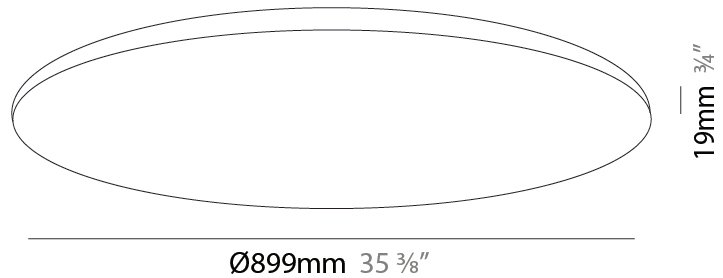

INFINITE ROUND SURFACE

A52030-

PROJECT

TYPE

SPECIFIER

QUANTITY

DATE

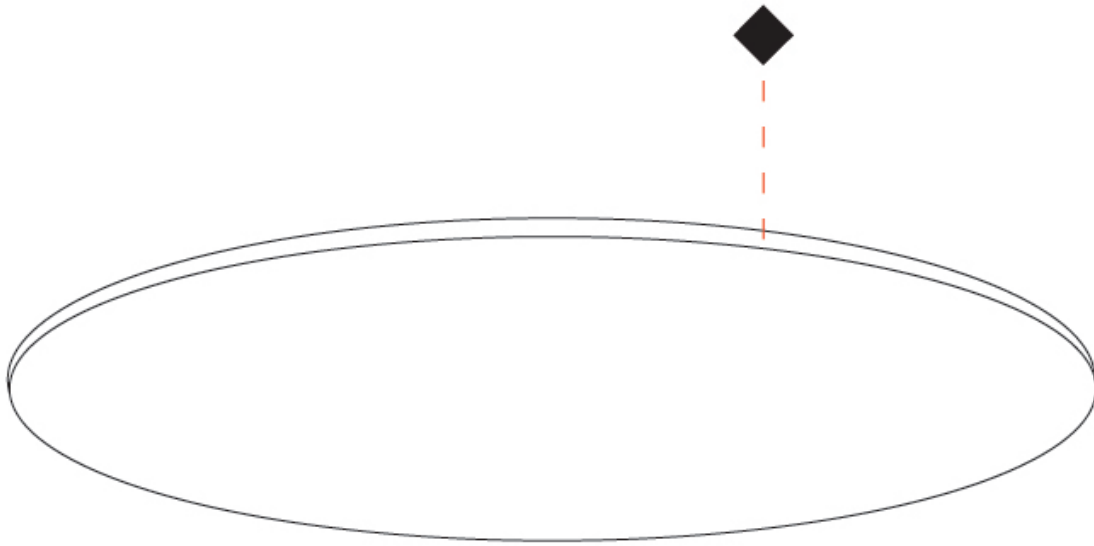

| |
|-----------|
| PROJECT |
| TYPE |
| SPECIFIER |
| QUANTITY |
| DATE |

INFINITE ROUND SURFACE

A52031- -
 base number Color Finish
 Temperature Options

- To build a product code in our configurator select the specify button on the base model # product page
- To build a manual product code on this datasheet choose from the options listed below in blue font and add the suffix to the base model #

GENERAL

Series: Infinite Round
 Partner: Ivela
 Division: Architectural
 Installation: Surface
 Product Type: Panels
 Mounting Location: Ceiling
 Light Distribution: Direct

PHYSICAL

Shape: Round
 Diameter (mm): 1216
 Diameter (in): 47 7/8
 Height (mm): 19
 Height (in): 3/4
 Diffuser: PMMA - Opal
 Fixture Finish: WHI / BLK / GLD
 Fixture Material: Aluminum

ELECTRICAL

Lamp Type: LED
 Input Wattage (W): 76
 Dimming: Tri-Mode (Non-Dimming and Phase Dimming (120Vac only) and 0-10V Dimming)
 Driver Included: No
 Driver Location: Remote
 Driver Type: Constant Voltage - Universal
 Driver Class: Class 2
 Housing: ENCP 5 (ERP) ENCP 8 (SC Power)
 Input Voltage (V): 120 - 277
 Output Voltage (V): 24

LED

Color Temperature (°K): 2700 / 3000 / 3500 / 4000
 Max. Delivered Lumen (lm): 4560 / 4750 / 4908 / 5035
 Nominal Lumen (lm): 9120 / 9500 / 9783 / 10070
 CRI: >93 CRI
 Lamp Life (hrs): 50000

OPTICAL

RATINGS AND CERTIFICATIONS

Certified By: CSA Certified to UL and CSA Standards
 IP rating: IP20

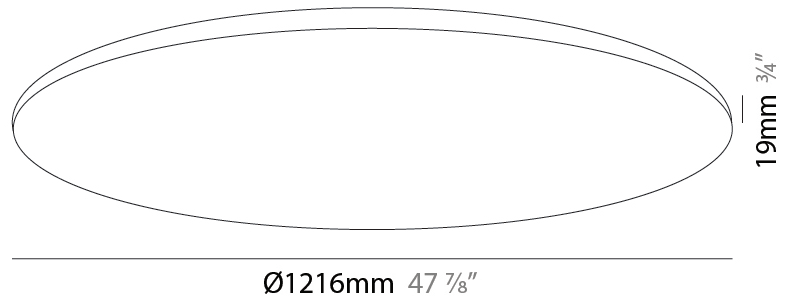

INFINITE ROUND SURFACE

A52031-

PROJECT

TYPE

SPECIFIER

QUANTITY

DATE

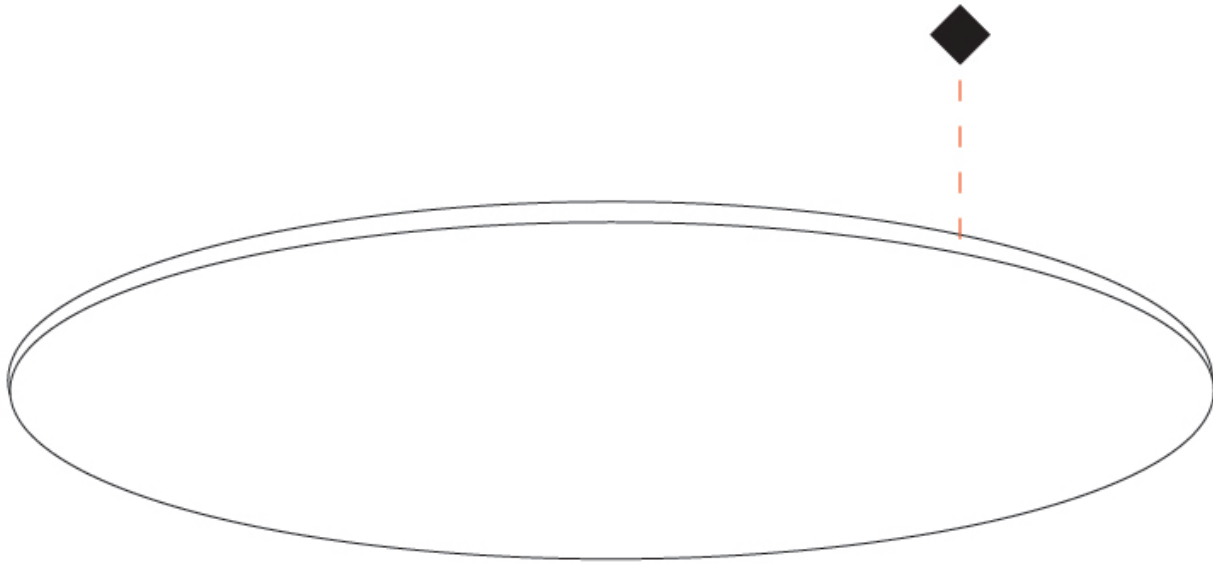

INFINITE ROUND RECESSED

A56179- -

base number Color Finish
 Temperature Options

- To build a product code in our configurator select the specify button on the base model # product page
- To build a manual product code on this datasheet choose from the options listed below in blue font and add the suffix to the base model #

GENERAL

Series: Infinite Round
 Partner: Ivela
 Division: Architectural
 Installation: Recessed
 Product Type: Panels
 Mounting Location: Ceiling
 Light Distribution: Direct

PHYSICAL

Shape: Round
 Diameter (mm): 612
 Diameter (in): 24 1/8
 Height (mm): 19
 Height (in): 3/4
 Diffuser: PMMA - Opal
 Fixture Finish: WHI / BLK / GLD
 Fixture Material: Aluminum

ELECTRICAL

Lamp Type: LED
 Input Wattage (W): 38
 Dimming: Tri-Mode (Non-Dimming and Phase Dimming (120Vac only) and 0-10V Dimming)
 Driver Included: No
 Driver Location: Remote
 Driver Type: Constant Voltage - Universal
 Driver Class: Class 2
 Housing: ENCP 5 (ERP) ENCP 13 (SC Power)
 Input Voltage (V): 120 - 277
 Output Voltage (V): 24

LED

Color Temperature (°K): 2700 / 3000 / 3500 / 4000
 Max. Delivered Lumen (lm): 2160 / 2250 / 2317 / 2385
 Nominal Lumen (lm): 4320 / 4500 / 4634 / 4770
 CRI: >93 CRI
 Lamp Life (hrs): 50000

OPTICAL

RATINGS AND CERTIFICATIONS

Certified By: CSA Certified to UL and CSA Standards
 IP rating: IP20

| |
|-----------|
| PROJECT |
| TYPE |
| SPECIFIER |
| QUANTITY |
| DATE |

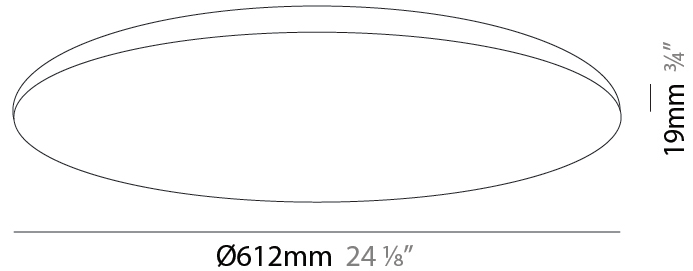

INFINITE ROUND RECESSED

A56179-

PROJECT

TYPE

SPECIFIER

QUANTITY

DATE

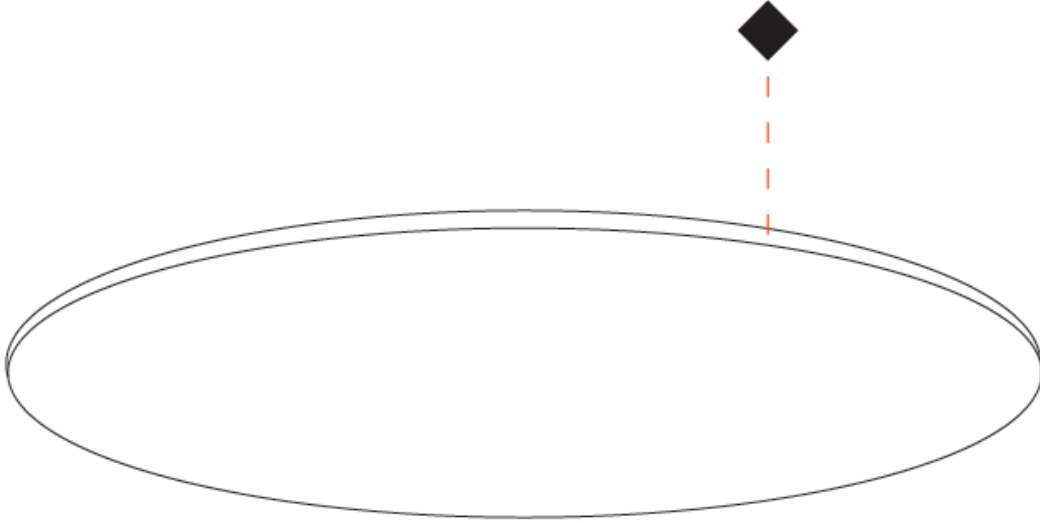

| |
|-----------|
| PROJECT |
| TYPE |
| SPECIFIER |
| QUANTITY |
| DATE |

INFINITE ROUND RECESSED

A56180- -
 base number Color Finish
 Temperature Options

- To build a product code in our configurator select the specify button on the base model # product page
- To build a manual product code on this datasheet choose from the options listed below in blue font and add the suffix to the base model #

GENERAL

Series: Infinite Round
 Partner: Ivela
 Division: Architectural
 Installation: Recessed
 Product Type: Panels
 Mounting Location: Ceiling
 Light Distribution: Direct

PHYSICAL

Shape: Round
 Diameter (mm): 899
 Diameter (in): 35 ³/₈
 Height (mm): 19
 Height (in): 3/4
 Diffuser: PMMA - Opal
 Fixture Finish: WHI / BLK / GLD
 Fixture Material: Aluminum

ELECTRICAL

Lamp Type: LED
 Input Wattage (W): 56
 Dimming: Tri-Mode (Non-Dimming and Phase Dimming (120Vac only) and 0-10V Dimming)
 Driver Included: No
 Driver Location: Remote
 Driver Type: Constant Voltage - Universal
 Driver Class: Class 2
 Housing: ENCP 5 (ERP) ENCP 8 (SC Power)
 Input Voltage (V): 120 - 277
 Output Voltage (V): 24

LED

Color Temperature (°K): 2700 / 3000 / 3500 / 4000
 Max. Delivered Lumen (lm): 3360 / 3500 / 3604 / 3710
 Nominal Lumen (lm): 6720 / 7000 / 7208 / 7420
 CRI: >93 CRI
 Lamp Life (hrs): 50000

OPTICAL

RATINGS AND CERTIFICATIONS

Certified By: CSA Certified to UL and CSA Standards
 IP rating: IP20

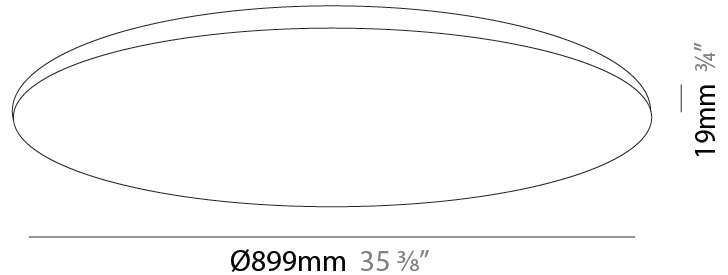

INFINITE ROUND RECESSED

A56180-

PROJECT

TYPE

SPECIFIER

QUANTITY

DATE

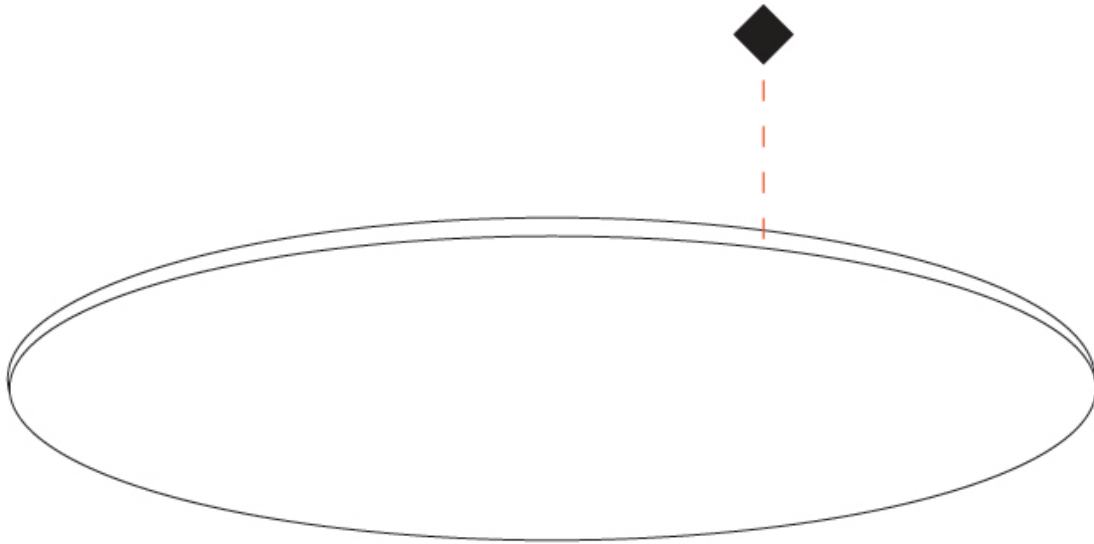

INFINITE ROUND RECESSED

A56181- -

base number Color Finish
 Temperature Options

- To build a product code in our configurator select the specify button on the base model # product page
- To build a manual product code on this datasheet choose from the options listed below in blue font and add the suffix to the base model #

GENERAL

Series: Infinite Round
 Partner: Ivela
 Division: Architectural
 Installation: Recessed
 Product Type: Panels
 Mounting Location: Ceiling
 Light Distribution: Direct

PHYSICAL

Shape: Round
 Diameter (mm): 1216
 Diameter (in): 47 ⁷/₈
 Height (mm): 19
 Height (in): 3/4
 Diffuser: PMMA - Opal
 Fixture Finish: WHI / BLK / GLD
 Fixture Material: Aluminum

ELECTRICAL

Lamp Type: LED
 Input Wattage (W): 76
 Dimming: Tri-Mode (Non-Dimming and Phase Dimming (120Vac only) and 0-10V Dimming)
 Driver Included: No
 Driver Location: Remote
 Driver Type: Constant Voltage - Universal
 Driver Class: Class 2
 Housing: ENCP 5 (ERP) ENCP 8 (SC Power)
 Input Voltage (V): 120 - 277
 Output Voltage (V): 24

LED

Color Temperature (°K): 2700 / 3000 / 3500 / 4000
 Max. Delivered Lumen (lm): 4560 / 4750 / 4891 / 5035
 Nominal Lumen (lm): 9120 / 9500 / 9783 / 10070
 CRI: >93 CRI
 Lamp Life (hrs): 50000

OPTICAL

RATINGS AND CERTIFICATIONS

Certified By: CSA Certified to UL and CSA Standards
 IP rating: IP20

| |
|-----------|
| PROJECT |
| TYPE |
| SPECIFIER |
| QUANTITY |
| DATE |

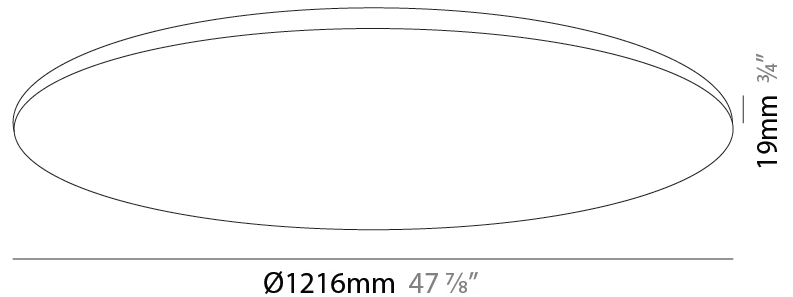

INFINITE ROUND RECESSED

A56181-

PROJECT

TYPE

SPECIFIER

QUANTITY

DATE

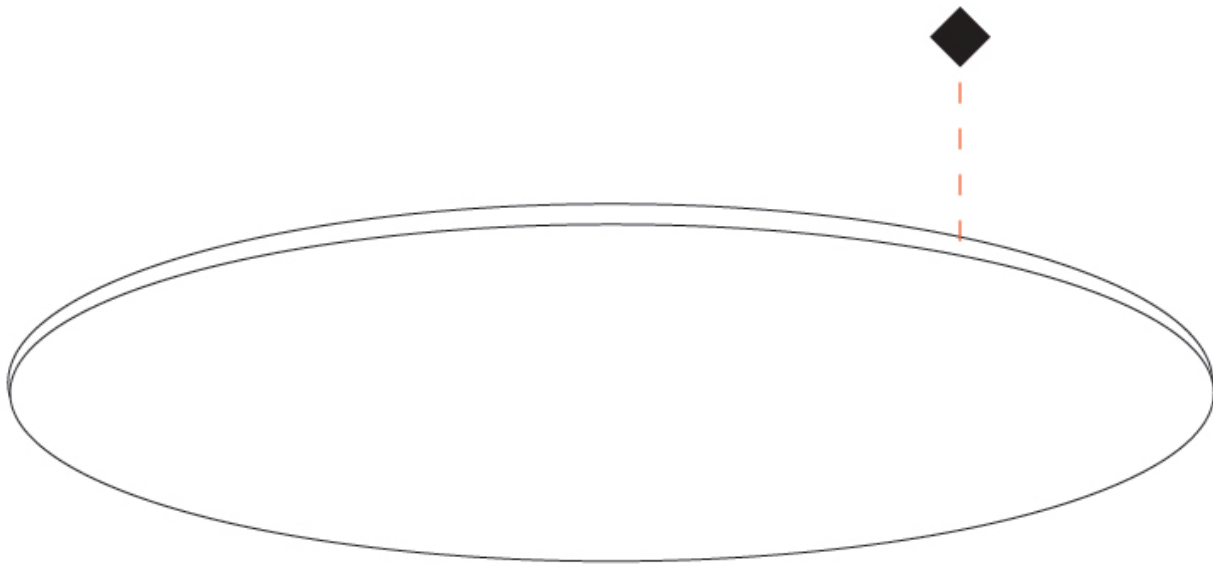

INFINITE ROUND COLOR FINISH CHART

PROJECT _____

TYPE _____

SPECIFIER _____

QUANTITY _____

DATE _____

Fixture Finish

White - WHI



Black - BLK

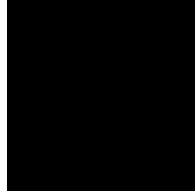

Gold - GLD



Digital: Not all screens are calibrated the same, and therefore, colors will appear differently between screens.

Physical: When texture is involved, there will be variations in color, character and tone within a product series and between product families.



LEGEND

| | | | | | |
|--|---|---|--|---|--|
|  | floor-mounted |  | pivotal |  | special LED (upon request) RGB, RGBW, tunable, gold+, meat+, art+, fashion+ |
|  | wall and ceiling: recessed and surface mounted |  | rotating |  | warm dim / natural dimming LED |
|  | ceiling-mounted and wall-mounted |  | illuminate tilted |  | rechargeable battery powered |
|  | wall-mounted |  | color of suspension cable |  | fixture with natural vivid LED (upon request) |
|  | omni-directional light distribution |  | length of suspension cable |  | color rendering index |
|  | direct light distribution |  | reflector degree selection |  | color temperature |
|  | direct/indirect light distribution |  | super spot |  | lumen (luminous flux) |
|  | indirect light distribution |  | lens |  | efficacy (lumens per watt) |
|  | asymmetric light distribution |  | lens pack |  | Unified Glare Rating (UGR) range from 5-40 |
|  | aura light distribution |  | shine ring |  | marine grade (AISI 316 stainless steel) |
|  | round wall or ceiling cut-out |  | integrated shine ring with diffuser |  | walk on |
|  | square wall or ceiling cut-out |  | free individual colors 01-29 |  | drive on |
|  | the supplied jig specifies the cutout dimensions |  | individual colors: 00 (free of charge), 01-25 (extra charge) |  | Dark Sky Compliance |
|  | minimum distance (meters) lamp - object |  | luminaire part to be colored (F1) |  | Americans with Disabilities Act (less than 4" off the wall located between 27"-84" from floor) |
|  | recessed depth |  | luminaire part to be colored (F2) |  | lamp protected against explosion |
|  | ceiling thickness in mm |  | luminaire part to be colored (F3) |  | blown glass using traditional methods by master glass blower |
|  | ceiling thickness selection |  | luminaire part to be colored (F4) |  | acoustic material |
|  | dimnable DP (phase), DV (0-10V), DD (dali), DS (step-dim) |  | luminaire part to be colored (F5) |  | protection class I, protection insulation |
|  | included or excluded LED driver/transformer/control gear |  | color of 3-circuit adaptor |  | protection class II, protection insulation |
|  | separately switchable |  | indirect diffuser |  | ETL Certified to UL and CSA Standards |
|  | sensor |  | direct diffuser |  | UL Certified to UL and CSA Standards |
|  | remote control |  | ball-proof (upon request) |  | CSA Certified to UL and CSA Standards |
|  | available upon request |  | accessory |  | Certified for North American Standards |

IP RATING

| | |
|---|--|
|  | protected against ingress of solid bodies greater than 12.5mm (finger) |
|  | protected against ingress of solid bodies greater than 2.5mm protected against sprays of water up to 60 degrees from the vertical (rain) |
|  | protected against ingress of solid bodies greater than 1mm (wire) no protection against the ingress of moisture |
|  | protected against ingress of solid bodies greater than 1mm (wire) protected against sprays of water up to 60 degrees from the vertical (rain) |
|  | protected against ingress of solid bodies greater than 1mm (wire) protected against water splashed from all directions |
|  | protected against limited ingress of dust (wet rooms/covered outdoor areas) protected against water splashed from all directions |
|  | protected against ingress of dust protected against jets of water |
|  | protected against ingress of dust protected against powerful jets of water or heavy seas |
|  | protected against ingress of dust protected against immersion of water between 15cm - 1m for 30 minutes |
|  | protected against ingress of dust protected against immersion of water under pressure for long periods |

IK RATING

| | |
|---|---|
|  | protected against 0.14 joules impact (equivalent to 0.25kg mass dropped from 56mm above the surface) |
|  | protected against 0.2 joules impact (equivalent to 0.25kg mass dropped from 80mm above the surface) |
|  | protected against 0.35 joules impact (equivalent to 0.25kg mass dropped from 140mm above the surface) |
|  | protected against 0.5 joules impact (equivalent to 0.25kg mass dropped from 200mm above the surface) |
|  | protected against 0.7 joules impact (equivalent to 0.25kg mass dropped from 280mm above the surface) |
|  | protected against 1 joules impact (equivalent to 0.25kg mass dropped from 400mm above the surface) |
|  | protected against 2 joules impact (equivalent to 0.5kg mass dropped from 400mm above the surface) |
|  | protected against 5 joules impact (equivalent to 1.7kg mass dropped from 300mm above the surface) |
|  | protected against 10 joules impact (equivalent to 5.0kg mass dropped from 200mm above the surface) |
|  | protected against 20 joules impact (equivalent to 5.0kg mass dropped from 400mm above the surface) |